

FEATURES

- ⊙ Accepts input rates up to 50KHz
- ⊙ Accept more type sensors(switch, encoder, proximity switch ,ı etc)finish length/flow control
- ⊙ Readout Range from -19999~99999
- ⊙ Seven counting modes:Front/after edge,Up,Down,Up/Down, direct-Up/Down ,Quadrature-Up/Down can be modified
- ⊙ Power down saving
- ⊙ Decimal point can be modified
- ⊙ Input scaling multiplied 0.0001~9.9999 can be modified
- ⊙ Reset by panel or connect terminal
- ⊙ Quadrature sensing up to 4 times resolution
- ⊙ 16BIT DAC analog output can be modified
- ⊙ Seven alarm control mode (N/F/R/Q/C/P/K) can be modified
- ⊙ RS485 Communication interface, Protocol MODBUS RTU MODE
- ⊙ BAUD RATE:38400/19200/9600/4800/2400
- ⊙ 0.4ö highlight display
- ⊙ Man-machine interface, easy to operate
- ⊙ EEPROM Saving, data safekeeping about 10 years
- ⊙ Modified inside parameter, must have pass code

Name of Parts

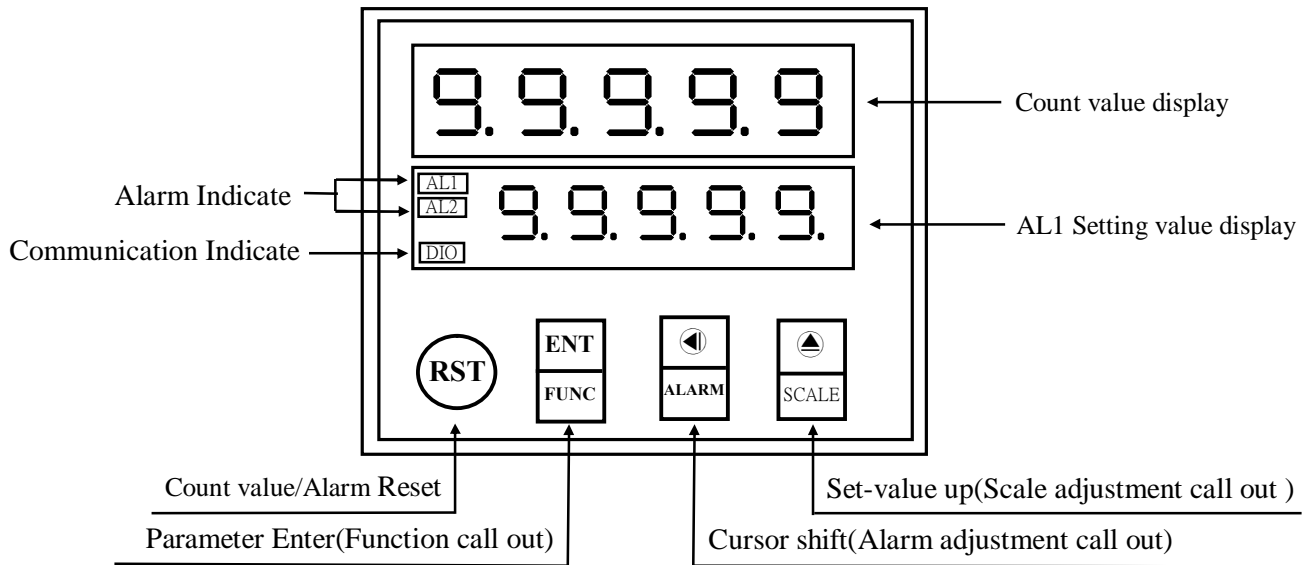

Connect Diagram

⊙ Contact input (PNP)

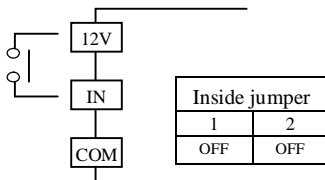

⊙ Contact input (NPN)

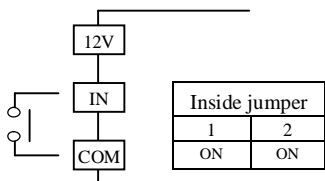

⊙ Sensor input (PNP 5V/12V)

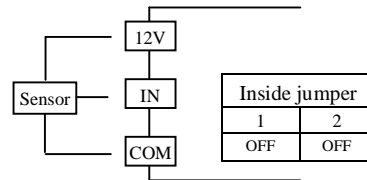

⊙ Sensor input (NPN 5V/12V)

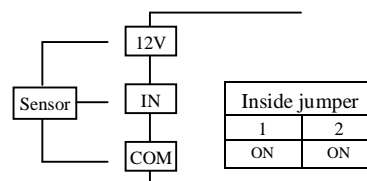

Inside jumper illustrates

- 1 Position 1 IN1 Input, ON = NPN,OFF = PNP
- 2 Position 2 IN2 Input, ON = NPN,OFF = PNP

Key Introduce

Operation Manual

⊙ Key Function	1.In normal display, The key function is call out setting group 2.In parameter setting page, The key function is data Enter , and go to next page
◀ Key Function	1.In normal display, The key function is call out alarm value setting page 2.Into parameter setting page, the parameter mark & data is alternate display, If need modify data can press ◀ key into setting procedure, The display is lock parameter data, this time must let off key about 0.2 sec, press again, the cursor(twinkle express)is cycle moving left. (Key Response about 0.2 sec)

▲Key Function	1.In normal display, The key function is call out adjustment display scale page 2.Into parameter setting page, the parameter mark & data is alternate display,If need modify data can press ▲ key into setting procedure, The display is lock parameter data, this time must let off key about 0.2 sec, press again, the parameter data will increment. (Key Response about 0.2 sec). If the setting value have negative,Shift cursor(twinkle express) to the leftest and Press▲ key can positive / negative number alternate display
◀&▲Key Function	1.In setting group or setting page press ◀&▲ key return normal display, but if in setting page the modify data will be lost
No Key in anything	1.In setting group or setting page no key in anything about 2 minutes, return normal display, but if in Setting page the modify data will be lost

Step	Parameter mark description	Parameter mark	Operation manual
1	Normal display	1 2 3 4 5	Press [F]/FUNC key into P.CODE setting page
2	P.CODE(Pass code input page)	P.C O D E	1.Key in 5 digit pass code with ◀ or ▲ key 2.Press [F] key, the pass code is right into setting group, otherwise return normal display
		0 0 0 0 0	
3	SYS(System setting group)	S Y S	1.Select setting group with ◀ key 2. Press [F] key into setting page of selection setting group
	ROP(Alarm setting group)	r o P	
	AOP(Analog output setting group)	A o P	
	DOP(Communication setting group)	d o P	
4	SYS(System setting group)	S Y S	1.Press ◀ key decide SYS setting group , press [F] key into DP setting page
4-1	DP(Decimal Point) Default = 0	d P	1.Decide decimal point position with ▲ key (0~4) 2. Press [F] key enter data and into TYPE setting page
		0.	
4-2	TYPE(Type) Default = 1U2G	T Y P E	1.Decide input type with ▲ key (1U2G,1G2U,1D2G,1G2D,1U2D,1P2D,1A2B) 2. Press [F] key enter data and into CNTS setting page
		1 U 2 G	
4-3	CNTS(Count Rates Select) Default = 50KHZ	C n t s	1.Decide Count Rates Select with ▲ key (50HZ,50KHZ) 2. Press [F] key enter data and into P.OFF.M setting page
		5 0 K H Z	
4-4	P.OFF.M(Power Off Mode) Default = RESET	P . o f f . m	1.Decide Power Off Mode with ▲ key (RESET or MEMOR) 2. Press [F] key enter data and into CODE setting page Note:RESET(Power Off Reset):Count value and Alarm is reset MEMOR(Power Off Memory) :Count value and Alarm is save
		r e s e t	
4-5	CODE(Pass Code) Default = 0	C o d e	1.Decide pass code with ◀ or ▲ key (0~99999) 2. Press [F] key enter data and into LOCK setting page
		0 0 0 0 0	
4-6	LOCK(Panel Lock) Default = NO	L o c k	1. Decide panel lock with ▲ key(NO or YES) 2. Press [F] key enter data and return SYS setting group
		n o	
5	ROP(Alarm setting group)	r o P	1.Press ◀ key decide ROP setting group, press [F] key into OP.MODE setting page
5-1	OP.MODE(Output Mode) Default = N	o P . m o d	1. Decide output mode with ▲ key (N,F,R,Q,C,P,K) 2. Press [F] key enter data and into ACT1.T setting page
		n	
5-2	ACT1.T(Active 1 Time) Default = 0	A c t 1 t	1.Decide Active 1 Time with ◀ or ▲ key (0.0~99.9)sec. 2. Press [F] key enter data and into ACT2.T setting page 3.ACT1.T=0 sec. is self-holding output 1 .ACT1.T=0.1~99.9 sec. is one-shot output 1 Note:When :OP.MODE=N, ACT1.T = 0 sec.
		0 0 . 0	
5-3	ACT2.T(Active 2 Time) Default = 0	A c t 2 t	1. Decide Active 2 Time with ◀ or ▲ key (0.0~99.9)sec. 2. Press [F] key enter data and return ROP setting group 3. ACT2.T=0 sec. is self-holding output 2 ACT2.T=0.1~99.9 sec. is one-shot output 2
		0 0 . 0	

6	AOP(Analog output setting group)	A O P	1.Press ◀ key decide AOP setting group , press Ⓜ key into ANLO setting page
6-1	ANLO(Analog Output Zero-According to Display) Default = 0	A N L O	1. Decide ANLO with ◀ or ▶ key (-19999~99999) 2. Press Ⓜ key enter data and into ANHI setting page
		0 0 0 0 0	
6-2	ANHI(Analog Output Span-According to Display) Default = 99999	A N H I	1. Decide ANHI with ◀ or ▶ key (-19999~99999) 2. Press Ⓜ key enter data and into AZERO setting page
		9 9 9 9 9	
6-3	AZERO(Analog Output Zero Adjust) Default = 0	A Z E R O	1. Adjustment analog output zero with ◀ or ▶ key (±5999) 2. Press Ⓜ key enter data and into ASPAN adjustment page
		0 0 0 0 0	
6-4	ASPAN(Analog Output Span Adjust) Default = 0	A S P A N	1. Adjustment analog output span with ◀ or ▶ key (±5999) 2. Press Ⓜ key enter data and return AOP setting group
		0 0 0 0 0	

7	DOP(Communication setting group)	d o p	1.Press ◀ key decide DOP setting group, press Ⓜ key into ADDR setting page
7-1	ADDR(Communication Address) Default = 0	A d d r	1.Decide address with ◀ or ▶ key(0~255) 2.Press Ⓜ key enter data and into BAUD setting page Note: When setting value is greater then 255,it will be return to zero.
		0 0 0	
7-2	BAUD(Communication Baud Rate) Default = 19200	b A U D	1. Decide baud rate with ▶ key (38400,19200,9600,4800,2400) 2. Press Ⓜ key enter data and into PARI setting page
		1 9 2 0 0	
7-3	PARI(Communication Parity Check) Default = n.8.2.	P A R I	1.Decide Parity Check with ▶ key(n.8.2.,n.8.1.,even,odd) 2.Press Ⓜ key enter data and return DOP setting group
		n . 8 . 2	

Step	Parameter mark description	Parameter mark	Operation manual
8	Normal display	1 2 3 4 5	Press ◀/ALARM key about 3 sec, into AL1 setting page
8-1	AL1 (Alarm 1) Default = 0	A L 1	1. Decide alarm value 1 with ◀ or ▶ key (0~99999) 2. Press Ⓜ key enter data and into AL2 setting page
		0 0 0 0 0	
8-2	AL2 (Alarm 2) Default = 0	A L 2	1. Decide alarm value 2 with ◀ or ▶ key (0~99999) 2. Press Ⓜ key enter data and return normal display
		0 0 0 0 0	

Step	Parameter mark description	Parameter mark	Operation manual
9	Normal display	1 2 3 4 5	Press ▶/SCALE key about 3 sec, into SCALE setting page
9-1	SCALE (Scale) Default = 1.0000	S C A L E	1. Decide scale with ◀ or ▶ key (0.0001~9.9999) 2. Press Ⓜ key enter data and return normal display
		1 . 0 0 0 0	

Appendix	Error Mark Description	Error Mark	Analyze & Description
1	EEPROM error detect	E - 0 0	1.External interference when EEPROM read/write 2.EEPROM write over 100000 times(guarantee 10 years) Please power reset, if still display E-00, doing following step: 1. E-00 & No display for inquire reset EEPROM 2. Decide Yes with ▶ key, press Ⓜ key return normal display 3. EEPROM has reset, Please follow step 1~9 setting again
		n o	
		Y E S	

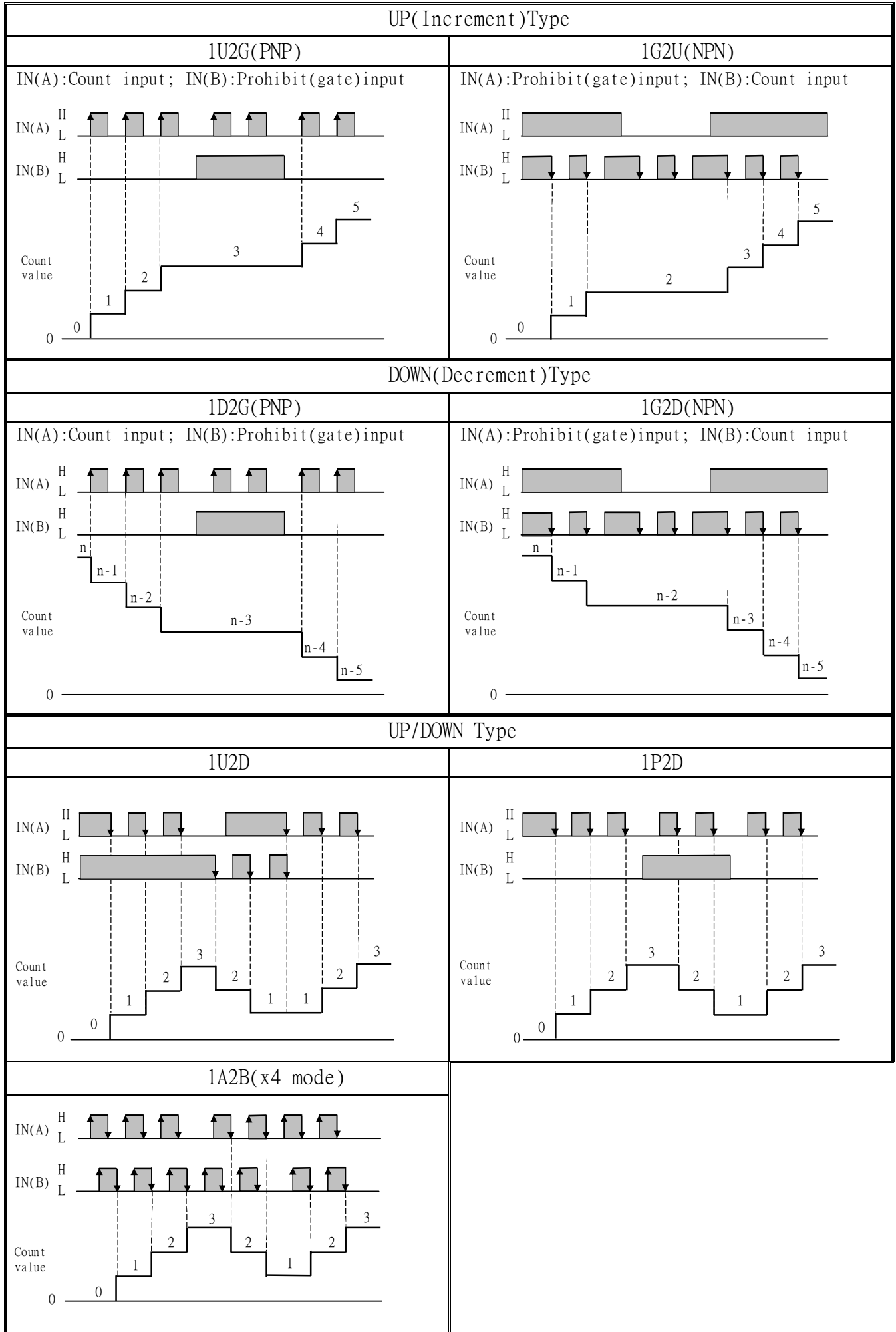

■ Input Type and Count Value



Alarm Output Mode Setting

		Input Type			Operation Description
		UP	DOWN	UP/DOWN	
Alarm Output Mode setting	N				<p>The display value continues to increase/decrease. The OUT1 output are held until Reset is input.</p>
	F				<p>As soon as OUT1 has active, the display value are held until Reset is input. The OUT2 output time is independent of OUT1.</p>
	R				<p>The display value continues to increase/decrease during the OUT1 one-shot output time but return to the reset start status after the OUT1 one-shot output time has elapsed. The output repeat OUT1 one-shot operation. OUT2 self-holding output turns OFF after the OUT1 one-shot output time. The OUT2 one-shot output time is independent of OUT1.</p>
	Q				<p>The display value return to the reset start status after the OUT1 one-shot output time. The output repeat OUT1 one-shot operation. OUT2 self-holding output turns OFF after the OUT1 one-shot output time. The OUT2 one-shot output time is independent of OUT1.</p>

		Input Type			Operation Description
		UP	DOWN	UP/DOWN	
Alarm Output Mode setting	C				As soon as the count reaches AL1, the display value return to the reset start status. The output repeat OUT1 one-shot operation. OUT2 self-holding output turns OFF after the OUT1 one-shot output time. The OUT2 one-shot output time is independent of OUT1.
	P				The display value dose not change during the OUT1 one-shot output time. but the actual count return to the reset start status. The output repeat OUT1 one-shot operation. OUT2 self-holding output turns OFF after the OUT1 one-shot output time. The OUT2 one-shot output time is independent of OUT1.
	K				The display value continues to increase/decrease. OUT2 self-holding output turns OFF after the OUT1 one-shot output time. The OUT2 one-shot output time is independent of OUT1.

Note : 1. Self-holding output  , One-shot output  , Self-holding output or One-shot output 
Self-holding output

- When count value reaches 99999, it return to 0, Count value below -19999, Down mode return to AL1, Up/Down mode return to 0
- Counting cannot be performed during Reset input.
- If Reset is input while one-shot output is ON, one-shot output turns OFF.
- If there is power failure while output is ON, output will turn ON again (P.OFF.M = 1) or Reset (P.OFF.M = 0) when the power supply has recovered.
- When count value reaches to alarm again during the One-shot output, the One-shot output time will be restart.
- Seven alarm output mode is according to AL1 setting value.

MC48 Modbus RTU Mode Protocol Address Map

Data format 16Bit/32Bit, sign bit 8000~7FFF(-32768~32767),80000000~7FFFFFFF(-2147483648~2147483647)

Address	Name	Description	Accept
0000	P.OFF.M	Power Off Mode, Input Range 0000~0001 (0~1)(0: RESET,1:MEMOR)	R/W
0001	DP	Decimal Point, Input Range 0000~0004 (0~4)(0:10 ⁰ ,1:10 ⁻¹ ,2:10 ⁻² ,3:10 ⁻³ ,4:10 ⁻⁴)	R/W
0002	TYPE	Input Type, Input Range 0000~0006 (0:1U2G,1:1G2U,2:1D2G,3:1G2D,4:1U2D,5:1P2D,6:1A2B)	R/W
0003	LOCK	Panel Lock, Input Range 0000~0001 (0~1)(NO/YES)	R/W
0004	OP.MODE	Output Mode, Input Range 0000~0006 (0~6)(0:N,1:F,2:R,3:Q,4:C,5:P,6:K)	R/W
0005	CNTS	Count Rates Select, Input Range 0000~0001 (0~1) (0:50HZ,1:50KHZ)	R/W
0006	ACT1.T	Active 1 Time, Input Range 0000~03E7 (0~99.9)	R/W
0007	ACT2.T	Active 2 Time, Input Range 0000~03E7 (0~99.9)	R/W
0008	ADDR	Communication Address, Input Range 0000~00FF(0~255)	R/W
0009	BAUD	Communication Baud Rate,Input Range 0000~0004(0~4)(0:38400,1:19200,2:9600,3:4800,4:2400)	R/W
000A	PARI	Communication Parity Check, Input Range 0000~0003(0~3)(0:N82,1:N81,2:EVEN,3:ODD)	R/W
000B	A_ZERO	Analog Output Zero Adjust, Input Range E891~176F(-5999~5999)	R/W
000C	A_SPAN	Analog Output Span Adjust, Input Range E891~176F(-5999~5999)	R/W
000D	CODE	Pass Code, Input Range 00000000~0001869F (0~99999)high word	R/W
000E		Pass Code, Input Range 00000000~0001869F (0~99999)low word	R/W
000F	SCALE	Scale, Input Range 00000001~0001869F (0.00001~9.9999)high word	R/W
0010		Scale, Input Range 00000001~0001869F (0.00001~9.9999)low word	R/W
0011	ANLO	Analog Output Zero According to Display, Input Range FFFF1E1~0001869F (-19999~99999)high word	R/W
0012		Analog Output Zero According to Display, Input Range FFFF1E1~0001869F (-19999~99999)low word	R/W
0013	ANHI	Analog Output Span According to Display, Input Range FFFF1E1~0001869F (-19999~99999)high word	R/W
0014		Analog Output Span According to Display, Input Range FFFF1E1~0001869F (-19999~99999)low word	R/W
0015	AL1	Alarm 1,Input Range 00000000~0001869F (0~99999)high word	R/W
0016		Alarm 1,Input Range 00000000~0001869F (0~99999)low word	R/W
0017	AL2	Alarm 2,Input Range 00000000~0001869F (0~99999)high word	R/W
0018		Alarm 2,Input Range 00000000~0001869F (0~99999)low word	R/W
0019	DISP	Display Value, Display Range FFFF1E1~0001869F (-19999~99999)high word	R
001A		Display Value, Display Range FFFF1E1~0001869F (-19999~99999)low word	R
001B	STATUS	Alarm Status, Display Range 0000~0007(0~7)Bit0:AL1,Bit1:AL2(0:OFF,1:ON)	R
001C	RST	Write = 0001(Function 06),Count Value/Alarm Reset	W