

AXE 6 Digit Microprocess Counter (72x72mm)

MC726 Series

Features

Accept more type sensors (switch, encoder, proximity, etc) Accept input rates up to 10KHz Readout range from -199999~999999 Four counting modes Up, Down, Up/Down, Quadrature Power down saving Decimal point can be modified Input scaling multiplied 0.00001~9.99999 can be modified Reset by panel or connect terminal	Quadrature sensing up to 4 times resolution Alarm output can programmable per-warn mode N,R,C alarm control mode Alarm output action times 0.1~99.9 sec. Can be modified 0.36" highlight display Man-machine interface, easy to operate EEPROM Saving, data safekeeping about 10 years Modified inside parameter, must have pass code
--	--

Name of parts

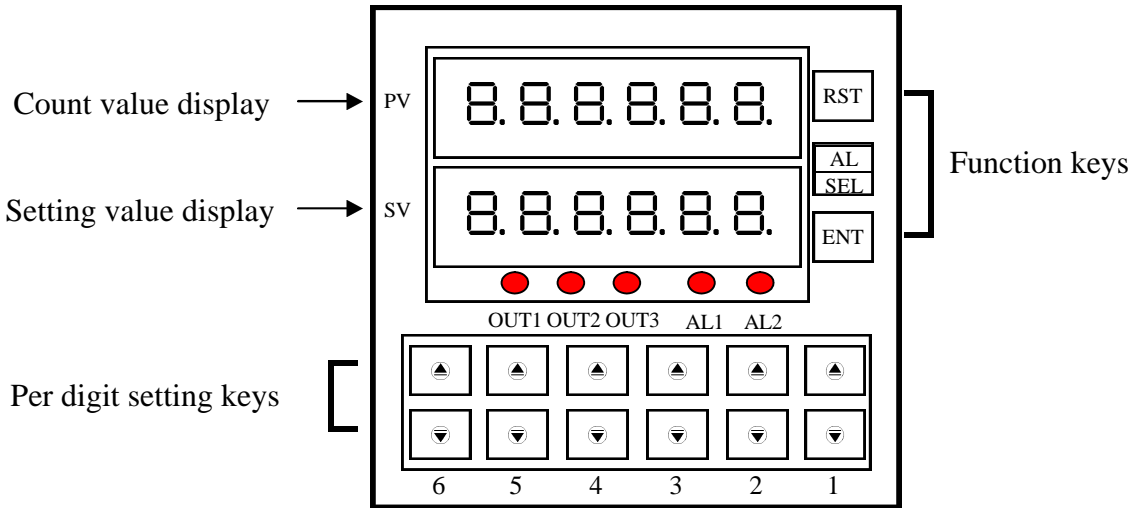

Connect diagram

Contact input (PNP)

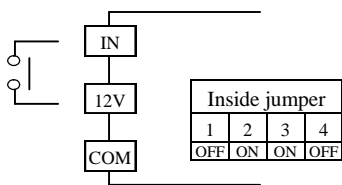

Contact input (NPN)

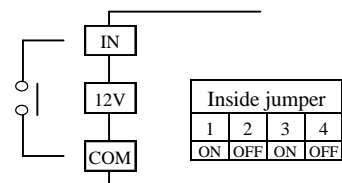

CMOS input (12V or 15V)

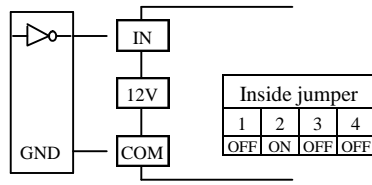

TTL input (5V)

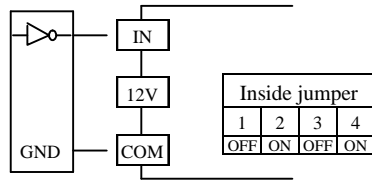

Sensor input (PNP 12V)

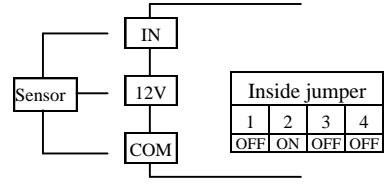

Sensor input (NPN 12V)

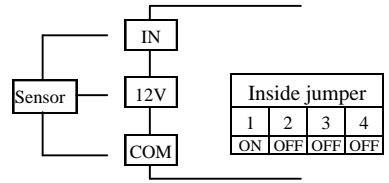

Alarm output control mode description

N (MANUAL): When count value equal setting value the relay ON & continue count until reset by panel or connect terminal then relay OFF & count value return to RST setting value

R (RETURN): When count value equal setting value the relay ON & continue count until relay action time out then relay OFF & count value return to RST setting value

C (CONTINUE): When count value equal setting value the relay ON & count value return to RST setting value then continue count & relay action time out the relay OFF

N/R/C control mode is according to AL1 setting value

WARN: When count to [AL1 value (digit 1-4) - warn value (digit 5-6)] RELAY 2 ON, count to AL1 value RELAY 1 ON

Key introduce		Operation Manual	
Ⓜ Key Function	1.In normal display,The key function is call out setting page 2.In parameter setting page,The key function is data Enter , and goto next page		
RSTKey Function	1.The key function is count value retuen to RST value & relay OFF		
AL SEL Key Function	1.In normal display,The key function is change alarm value & alarm indicate display		
Per digit ▲/▼ Key Function	1.In normal display,according to alarm indicate press per digit ▲/▼ key setting per alarm value 2.Into parameter setting page,If need modify data can press per digit ▲/▼ key into setting procedure ,The parameter data will increment /decrement. (Key Response about 0.2 sec)		
Digit 1 ▲&▼ Key Function	In setting page press digit 1 ▲&▼ key return normal display,but if in setting page the modify data will be lost		
No Key in anything	In setting page no key in anything about 2 minutes,return normal display,but if in setting page the modify data will be lost		
Step	Parameter Mark Description	Parameter Mark	Operation Manual
1	Normal display	1 2 3 4 5 6	Press Ⓜ/FUNC key into P.COD setting page
		1 2 3 4 5 6	
2	P.COD(Pass code input page)	P.C o d	1.Key in 6 digit pass code with per digit ▲ or ▼ key 2.Press Ⓜ key,the pass code is right into setting page , otherwise return normal display
		0 0 0 0 0 0	
3	TYPE(Input Type setting page) Default=1U2D	t y p e	1.Decide input type with digit 1 ▲ or ▼ key (1U2D/1P2D/1A2B) 2.Press Ⓜ key enter data and into WARN setting page
		1 U 2 d	
4	WARN(Pre-Warn) Default = NO	u a r n	1.Decide pre-warn mode with digit 1 ▲ or ▼ key(NO,YES) 2.Press Ⓜ key enter data and into RST setting page
		n o	
5	RST(Reset Value) Default=0	r s t	1.Decide reset value with per digit ▲&▼ key(-199999~999999) 2.Press Ⓜ key enter data and into DP setting page
		0 0 0 0 0 0	
6	DP(Decimal Point) Default=0	d p	1.Decide decimal point with digit 1 ▲&▼ key(0~5) 2.Press Ⓜ key enter data and into SCALE setting page
		0 0 0 0 0 0	
7	SCALE(Display Scale) Default=1	s c a l e	1.Decide display scale with per digit ▲&▼ key(0.00001~9.99999) 2.Press Ⓜ key enter data and into OP.MODE setting page
		1 0 0 0 0 0	
8	OP.MODE(Output Mode) Default=N	o p . n o d e	1.Decide output mode with digit 1 ▲&▼ key(N,R,C) 2.Press Ⓜ key enter data and into ACT.T setting page
		n	
9	ACT.T(Active Time) Default=0.1	a c t . t	1.Decide active time with digit 1~3 ▲&▼ key(0.1~99.9 sec.) 2.Press Ⓜ key enter data and into CODE setting page
		0 0 0 0 0 . 1	
10	CODE(Pass Code) Default=0	c o d e	1.Decide pass code with per digit ▲&▼ key(0~999999) 2.Press Ⓜ key enter data and into LOCK setting page
		0 0 0 0 0 0	
11	LOCK(Panel Lock) Default=NO	l o c k	1.Decide panel lock with digit 1 ▲&▼ key(NO,YES) 2.Press Ⓜ key enter data and return TYPE setting page
		n o	
Step	Parameter Mark Description	Parameter Mark	Operation Manual
1	Setting alarm 1 value Default=0	1 2 3 4 5 6	1.Press AL/SEL key,until AL1 indicate is light 2.Decide alarm 1 value with per digit ▲&▼ key(-199999~999999) ,no key in any key 5 sec. Auto save data
		1 2 3 4 5 6	
2	Setting alarm 2 value Default=0	1 2 3 4 5 6	1.Press AL/SEL key,until AL2 indicate is light 2.Decide alarm 2 value with per digit ▲&▼ key(-199999~999999) ,no key in any key 5 sec. Auto save data
		1 2 3 4 5 6	